

# CM15MD-12H

MEDIUM POWER SWITCHING USE  
INSULATED TYPE

## CM15MD-12H

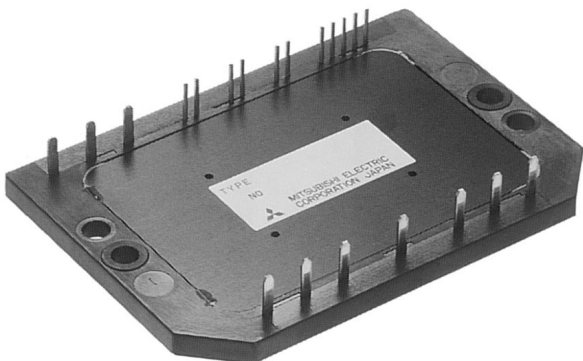

- IC ..... 15A
- VCES ..... 600V
- Insulated Type
- CIB Module
- 3φ Inverter+3φ Converter+Brake
- UL Recognized

Yellow Card No. E80276 (N)  
File No. E80271

## APPLICATION

AC & DC motor controls, General purpose inverters, Servo controls, NC, Robotics

## OUTLINE DRAWING & CIRCUIT DIAGRAM

Dimensions in mm

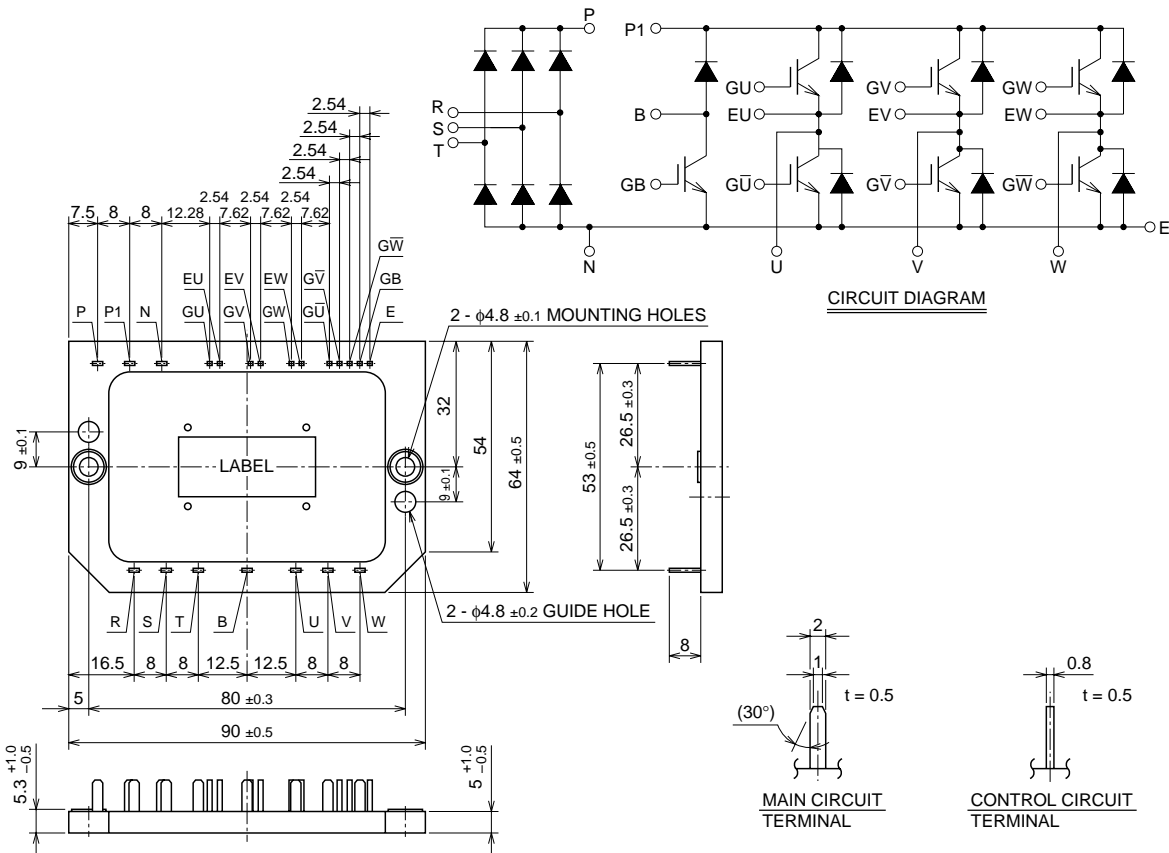

Note. Not use the guiding holes to mount on the cooling fin.

## CM15MD-12H

MEDIUM POWER SWITCHING USE  
INSULATED TYPE**MAXIMUM RATINGS** ( $T_j = 25^\circ\text{C}$ )  
**INVERTER PART**

Symbol	Parameter	Condition	Rating	Unit
V <sub>CES</sub>	Collector-emitter voltage	G – E Short	600	V
V <sub>GES</sub>	Gate-emitter voltage	C – E Short	±20	V
I <sub>C</sub>	Collector Current	T <sub>C</sub> = 25°C	15	A
I <sub>CM</sub>		PULSE (Note. 2)	30	A
I <sub>E</sub> (Note. 1)	Emitter Current	T <sub>C</sub> = 25°C	15	A
I <sub>EM</sub> (Note. 1)		PULSE (Note. 2)	30	A
P <sub>C</sub> (Note. 3)	Maximum collector dissipation	T <sub>f</sub> = 25°C	45	W

**BRAKE PART**

Symbol	Parameter	Condition	Rating	Unit
V <sub>CES</sub>	Collector-emitter voltage	G – E Short	600	V
V <sub>GES</sub>	Gate-emitter voltage	C – E Short	±20	V
I <sub>C</sub>	Collector Current	T <sub>C</sub> = 25°C	15	A
I <sub>CM</sub>		PULSE (Note. 2)	30	A
P <sub>C</sub> (Note. 3)	Maximum Collector dissipation	T <sub>f</sub> = 25°C	45	W
V <sub>RRM</sub>	Repetitive peak reverse voltage	Clamp diode part	600	V
I <sub>FM</sub> (Note. 3)	Forward current	Clamp diode part	15	A

**CONVERTER PART**

Symbol	Parameter	Condition	Rating	Unit
V <sub>RRM</sub>	Repetitive peak reverse voltage		800	V
E <sub>a</sub>	Recommended AC input voltage		220	V
I <sub>O</sub>	DC output current	3 $\phi$ rectifying circuit	15	A
I <sub>FSM</sub>	Surge (non-repetitive) forward current	1 cycle at 60Hz, peak value Non-repetitive	150	A
I <sup>2</sup> t	I <sup>2</sup> t for fusing	Value for one cycle of surge current	93	A <sup>2</sup> s

**COMMON RATING**

Symbol	Parameter	Condition	Rating	Unit
T <sub>j</sub>	Junction temperature		-40 ~ +150	°C
T <sub>stg</sub>	Storage temperature		-40 ~ +125	°C
V <sub>iso</sub>	Isolation voltage	AC 1 min.	2500	V
—	Mounting torque	Mounting M4 screw	1.47 ~ 1.96	N · m
—	Weight	Typical value	60	g

## CM15MD-12H

MEDIUM POWER SWITCHING USE  
INSULATED TYPEELECTRICAL CHARACTERISTICS (T<sub>j</sub> = 25°C)  
INVERTER PART

Symbol	Parameter	Test conditions	Limits			Unit
			Min.	Typ.	Max.	
ICES	Collector cutoff current	VCE = VCES, VGE = 0V	—	—	1	mA
VGE(th)	Gate-emitter threshold voltage	IC = 1.5mA, VCE = 10V	4.5	6	7.5	V
IGES	Gate-emitter cutoff current	VGE = VGES, VCE = 0V	—	—	0.5	μA
VCE(sat)	Collector-emitter saturation voltage	T <sub>j</sub> = 25°C	—	2.1	2.8	V
		T <sub>j</sub> = 150°C	—	2.15	—	
Cies	Input capacitance	VCE = 10V VGE = 0V	—	—	1.5	nF
Coes	Output capacitance		—	—	1.2	nF
Cres	Reverse transfer capacitance		—	—	0.3	nF
QG	Total gate charge	VCC = 300V, IC = 15A, VGE = 15V	—	45	—	nC
td(on)	Turn-on delay time	VCC = 300V, IC = 15A	—	—	120	ns
tr	Turn-on rise time	VGE1 = VGE2 = 15V	—	—	300	ns
td(off)	Turn-off delay time	RG = 42Ω	—	—	200	ns
tf	Turn-off fall time	Resistive load	—	—	300	ns
VEC (Note. 1)	Emitter-collector voltage	IE = 15A, VGE = 0V	—	—	2.8	V
trr (Note. 1)	Reverse recovery time	IE = 15A, VGE = 0V	—	—	110	ns
Qrr (Note. 1)	Reverse recovery charge	die / dt = -30A / μs	—	0.04	—	μC
R <sub>th(j-f)Q</sub> (Note. 5)	Thermal resistance	IGBT part, Per 1/6 module	—	—	2.8	°C/W
R <sub>th(j-f)R</sub> (Note. 5)		FWDi part, Per 1/6 module	—	—	3.5	°C/W

## BRAKE PART

Symbol	Parameter	Condition	Limits			Unit
			Min.	Typ.	Max.	
ICES	Collector cutoff current	VCE = VCES, VGE = 0V	—	—	1	mA
VGE(th)	Gate-emitter threshold voltage	IC = 1.5mA, VCE = 10V	4.5	6	7.5	V
IGES	Gate-emitter cutoff current	VGE = VGES, VCE = 0V	—	—	0.5	μA
VCE(sat)	Collector-to-emitter saturation voltage	T <sub>j</sub> = 25°C	—	2.1	2.8	V
		T <sub>j</sub> = 150°C	—	2.15	—	
Cies	Input capacitance	VCE = 10V VGE = 0V	—	—	1.5	nF
Coes	Output capacitance		—	—	1.2	nF
Cres	Reverse transfer capacitance		—	—	0.3	nF
QG	Total gate charge	VCC = 300V, IC = 15A, VGE = 15V	—	45	—	nC
VFM	Forward voltage drop	IF = 15A, Clamp diode part	—	—	1.5	V
R <sub>th(j-f)Q</sub> (Note. 5)	Thermal resistance	IGBT part	—	—	2.8	°C/W
R <sub>th(j-f)R</sub> (Note. 5)		Clamp diode part	—	—	3.6	°C/W

## CONVERTER PART

Symbol	Parameter	Condition	Limits			Unit
			Min.	Typ.	Max.	
IRRM	Repetitive reverse current	VR = VRRM, T <sub>j</sub> = 150°C	—	—	8	mA
VFM	Forward voltage drop	IF = 15A	—	—	1.5	V
R <sub>th(j-f)</sub> (Note. 5)	Thermal resistance	Per 1/6 module	—	—	3.6	°C/W

Note 1. IE, VEC, trr, Qrr & die/dt represent characteristics of the anti-parallel, emitter to collector free-wheel diode.

2. Pulse width and repetition rate should be such that the device junction temp. (T<sub>j</sub>) does not exceed T<sub>jmax</sub> rating.

3. Junction temperature (T<sub>j</sub>) should not increase beyond 150°C.

4. Pulse width and repetition rate should be such as to cause negligible temperature rise.

5. Thermal resistance is specified under following conditions.

- The conductive grease applied, between module and fin.
- Al plate is used as fin.

# CM15MD-12H

MEDIUM POWER SWITCHING USE  
INSULATED TYPE

## PERFORMANCE CURVES

**OUTPUT CHARACTERISTICS (TYPICAL)**

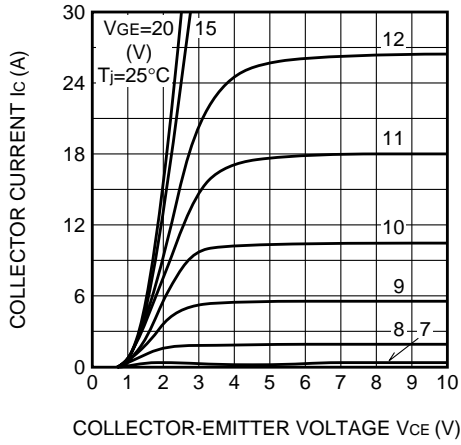

**TRANSFER CHARACTERISTICS (TYPICAL)**

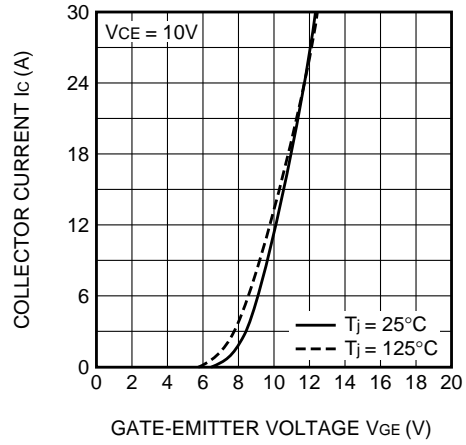

**COLLECTOR-EMITTER SATURATION VOLTAGE CHARACTERISTICS (TYPICAL)**

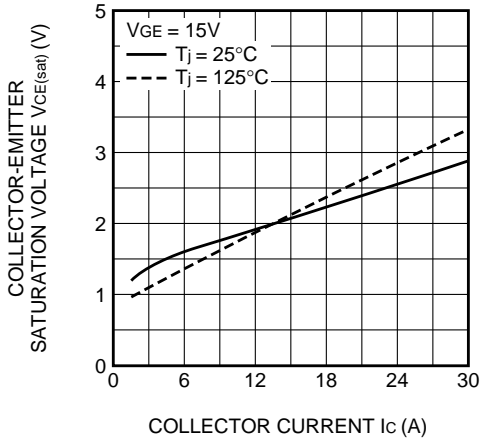

**COLLECTOR-EMITTER SATURATION VOLTAGE CHARACTERISTICS (TYPICAL)**

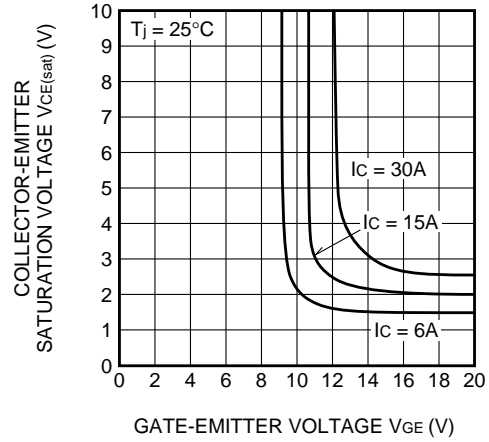

**FREE-WHEEL DIODE FORWARD CHARACTERISTICS (TYPICAL)**

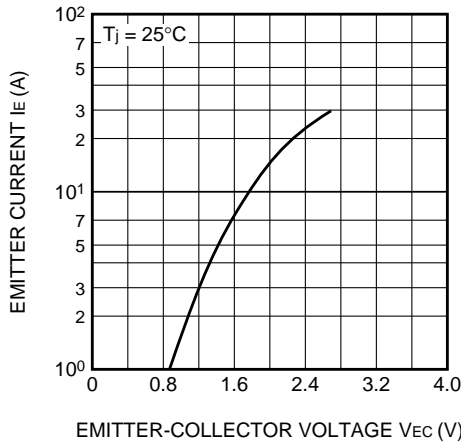

**CAPACITANCE VS. VCE (TYPICAL)**

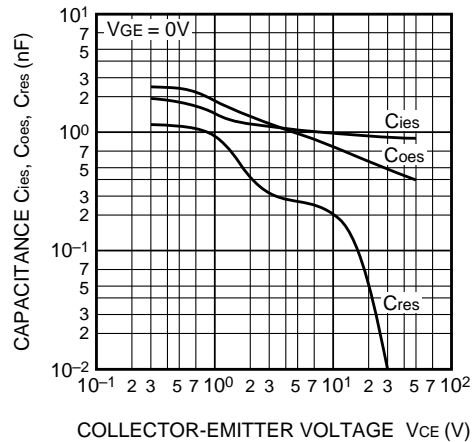

# CM15MD-12H

MEDIUM POWER SWITCHING USE  
INSULATED TYPE

**HALF-BRIDGE SWITCHING CHARACTERISTICS (TYPICAL)**

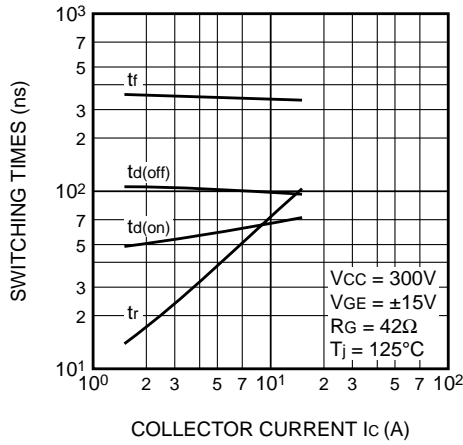

**REVERSE RECOVERY CHARACTERISTICS OF FREE-WHEEL DIODE (TYPICAL)**

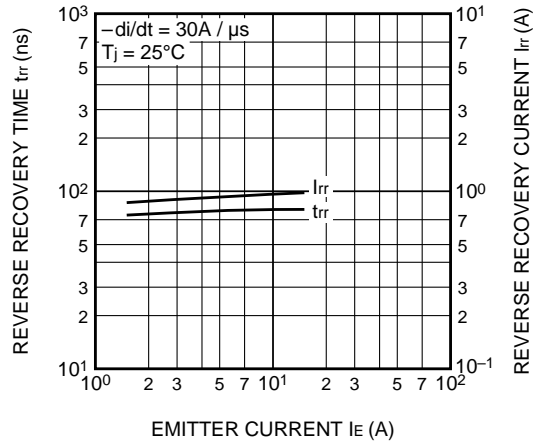

**TRANSIENT THERMAL IMPEDANCE CHARACTERISTICS (IGBT part)**

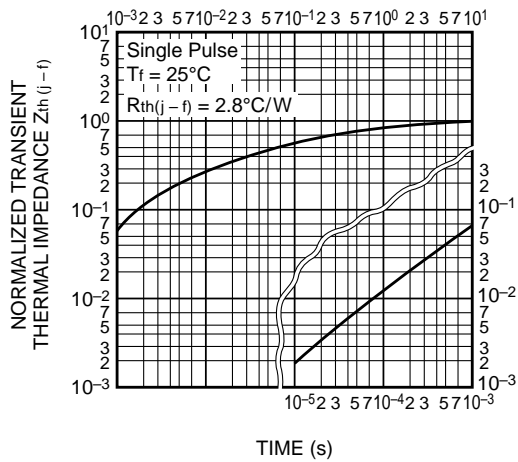

**TRANSIENT THERMAL IMPEDANCE CHARACTERISTICS (FWDi part)**

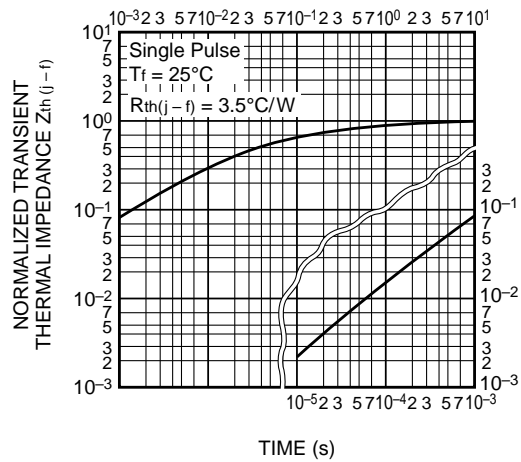

**$V_{GE}$  - GATE CHARGE (TYPICAL)**

